

General Specifications

Model UT551 Digital Indicating Controller with Active Color PV Display



GS 05D01C04-01E

■ General

Model UT551 Digital Indicating Controller is an intelligent, micro-processor based digital indicating controller with powerful control capability. It has a user-friendly large numerical display with the PV display color changing function "Active Color PV Display." The UT551 features as standard many functions which are necessary for various control applications, and all of these functions such as control function, control computation function, signal computation function, etc. can be configured by using the keys on the front panel. The instrument has eight types of control strategies and also an overshoot suppressing function "SUPER" and a hunting suppressing function "SUPER 2" as well as an auto-tuning function built in as standard. It is suitable for a diverse range of applications, with position-proportional control model and heating/cooling control model also available.

■ Main Features

- Extra-large digital display allows the indicated values to be read even from a long distance. LEDs of 20 mm height are used for the PV display. This is a five-digit display for higher resolution.
- Eight types of control function, including single-loop control, cascade control, loop control with PV auto-selector, and loop control with PV-hold function, enabling the operator to start control operation immediately after simply entering the settings.
- Parameters can easily be set using a personal computer. ("Parameter setting tool (model LL100)" sold separately is required.)
- Universal input and output enables users to set or change freely the type of PV inputs, PV input range, type of control output, etc. from the front panel.
- In addition to standard type (universal output), the position-proportional type (relay output) or the heating/cooling type (universal output) can be specified.
- Contact inputs (up to 8 points) and contact outputs (up to 8 points) can be employed and functions can be assigned to each contact. (The maximum number of points varies the suffix code.)
Note: See Hardware Specifications and Contact Outputs described later.
- Various communication function are provided. Communication is possible with personal computer, programmable logic controller, and other controllers.

■ Functional Specifications

● Control Functions

UT Mode

The following types of basic control structure can be set as the UT mode by the user.

- Single-loop control (UT mode 1):
The most simple and basic control function.
- Cascade primary-loop control (UT mode 2):
Output tracking function and cascade control logic are provided. Suitable for cascade primary-loop control.
- Cascade secondary-loop control (UT mode 3):
Setpoint output and cascade control logic are provided. Suitable for cascade secondary-loop control.

UT551



Indication in green or red color

UT551E

"E" indicates the model with expanded functions.

Cascade control (UT mode 4):

Dual control function for cascade control is available in a single instrument.

Loop control for back-up (UT mode 5):

Output tracking function is provided to back up another control instrument. The local and remote control outputs are switched by a contact input.

Loop control with PV switching (UT mode 6):

Two PV inputs are switched for control depending on the status of contact input or PV input.

Loop control with PV auto-selector (UT mode 7):

Two PV inputs are automatically selected for control with a high, low, average, or temperature-difference value selector.

Loop control with PV-hold function (UT mode 8):

This control holds a PV input and a control output if an external sensor is switched.

● Control Computation Functions

In each UT mode, the following control computation functions can be selected:

Continuous PID control, Time-proportional PID control, Relay ON/OFF control, Position-proportional PID control (for UT551-1□, UT551-4□) and Heating/Cooling control (for UT551-1□).

Target setpoint and PID parameters:

Maximum eight sets of target setpoint and PID parameters can be set. These eight sets can be set for both the main and slave loops in cascade control.

Zone PID selection:

The PV input range is divided into a maximum of seven zones with up to six reference points, and PID parameters are selected for every zone.

Zone PID selection (by target setpoint):

The setting range is divided into a maximum of seven zones with up to six reference points, and PID parameters are selected for every zone.

PID selection by external contact input:

PID No. 1 to 8 is selected by contact input.

- Auto-tuning:**
Available as standard. Possible to activate auto-tuning for both main and slave loops for cascade control.
- "SUPER" function:**
Overshoots generated by abrupt changes in the target setpoint or by disturbances can be suppressed.
- "SUPER 2" function:**
This function stabilizes the state of control that is unstable due to hunting, etc. without requiring any change in PID constants, when the load and/or gain varies greatly, or when there is a difference between the characteristics of temperature zones.
- Preset output function:**
When the instrument is in STOP mode, PV input is burnt-out, or an abnormality is found in an input circuit, a preset value is output as a control output.
- Sampling period**
Each sampling period can be selected under the following conditions:
- 50 ms: Available for model code UT551-00, when UT mode is set to Single-loop control and the following functions are not used: "SUPER" function, "SUPER 2" function, heating/cooling control, PV input computation, setpoint rate-of-change limiter, MV output rate-of-change limiter, deviation alarm, sensor grounding alarm, fault diagnosis alarm, and FAIL output.
 - 100 ms: Available when UT mode is not cascade control.
 - 200 ms: Available when UT mode is cascade control. (Set value when shipped from the factory: 200 ms)
 - 500 ms: Always available.

Operation Mode Switching

(Note: Communication enables all the following mode switching to be executed.)

- AUTO/MANUAL switching:**
Bumpless/preset output value switching between automatic operation mode and manual control mode is available by using the front keys or contact input. The contact input has priority over front key input or switching by communication. The contact input is invalid for Cascade secondary-loop control or Cascade control.
- RUN/STOP switching:**
Switching by contact input (bumpless for switching from STOP to RUN). The contact input has priority over switching by communication. In RUN mode, control computation is activated. In STOP mode, control computation ceases and a preset value is output as a control output while other functions operate normally.
- REMOTE/LOCAL switching:**
Switching between remote setpoint and local setpoint by instrument operation or contact input. The contact input has priority over instrument operation or switching by communication. For remote to local switching, either bumpless tracking (employing the remote setpoint on switching as the local setpoint) or without tracking (directly switching the local setpoint) can be specified.
- CASCADE/AUTO/MANUAL switching:**
Switching by instrument operation or contact input. The contact input has priority over instrument operation or switching by communication. Valid for Cascade secondary-loop control or Cascade control.

- Output tracking ON/OFF switching:**
Provided for Cascade primary-loop control or Loop control for backup. External tracking signal and internal control output are switched by the contact input. The contact input has priority over the switching by communication.

Control Parameters Setting Range

- Proportional band:** 0.1 to 999.9%
0.0 to 999.9% (for heating/cooling PID control), 0.0% available for ON/OFF control
- Integral time:** 1 to 6,000 s, or OFF (for Manual reset)
- Derivative time:** 1 to 6,000 s, or OFF
- ON/OFF control hysteresis:** 0.0 to 100.0% of PV input range span
- Preset output:** -5.0 to 105.0% (0 mA or less cannot be output)
- Output limiter:**
Setting range: -5.0 to 105.0% for both high and low limits
However, "low limit setpoint < high limit setpoint" must be satisfied.
In case of heating/cooling PID control, upper limiter for heating and upper limiter for cooling.
- Shutdown function:**
When manual control is carried out with 4 to 20 mA output, control output can be output down to about 0 mA (shutdown is specified for -5.0% or less).
- Rate-of-change limiter for output:**
OFF or 0.1 to 100.0%/s
- Deadband for heating/cooling control:**
-100.0 to 50.0% for output value
- Deadband for position-proportional control:**
1.0 to 10.0% for output

● Configuration of Input/Output Signal

PV Input Computations

Input processing, Square root extraction (voltage input only, Input low cut 0.0 to 5.0%), Ten-segment linearizer function, Ten-segment bias, Bias addition (-100.0 to 100.0%), and First order lag filter (OFF, time constant 1 to 120 s)

Auxiliary Input Computations

(Applied to remote setting input only)

Input processing, Square root extraction (Input low cut 0.0 to 5.0%), Bias addition (-100.0 to 100.0%), Ratio multiplication (0.001 to 9.999), First order lag filter (OFF, time constant 1 to 120 s)

● Alarm Functions

Alarm types:

PV high limit, PV low limit, Deviation high limit, Deviation low limit, De-energized on deviation high limit, De-energized on deviation low limit, Deviation high and low limits, High and low limits within deviation, De-energized on PV high limit, De-energized on PV low limit, SP high limit, SP low limit, Output high limit, Output low limit, Deviation high limit for target setpoint, Deviation low limit for target setpoint, De-energized on deviation high limit alarm for target setpoint, De-energized on deviation low limit alarm for target setpoint, Deviation high and low limits for target setpoint, and Deviation within high and low limits for target setpoint.

Alarm setting range:

PV/SP alarm: -100 to 100% of PV input range
Deviation alarm: -100 to 100% of PV input range span
Output alarm: -5.0 to 105.0% of output value
Alarm hysteresis: 0.0 to 100.0% of PV input range span

Delay timer:
0.00 to 99.59 (minute, second)
An alarm is output when the delay timer expires after the alarm setpoint is reached. Setting for each alarm is possible.

Stand-by action:
Stand-by action can be set to make PV/deviation alarm OFF during start-up or after SP change until SP reaches the normal region.

Timer function (stabilization of control status notification event) (Alarm 1 only):
This function sets the alarm 1 output to ON when a preset time (timer setting) elapses after a PV has reached the control target setpoint hysteresis band to notify that control has reached its stabilized status. Restarted in RUN/STOP or SP switching.

Other alarm actions:
Sensor grounding alarm: Detects sensor deterioration and outputs an alarm.
Fault-diagnosis alarm: For input burnout, A/D conversion error, or thermocouple reference junction compensation error.
FAIL output: Abnormality in software or hardware.

Number of alarm settings: 8 (maximum)
The alarm status can be read via communication in addition to output as the above alarm output.

Alarm output points (see also the item "Contact Outputs")

- Number of contact (relay) outputs:
3 (standard) or 4 (if a control output relay is used for the alarm 4 output relay.)
- Number of contact (transistor open collector) outputs:
4 (when optional function code is specified as 1 or 3)

From the above, up to 8 point outputs can be obtained (except for cascade control).
Any of PV alarm, deviation alarm, SP alarm, output alarm, Fault-diagnosis alarm, sensor grounding alarm and FAIL output can be assigned to contacts for the above number of outputs. However, the timer delay alarm can be assigned to the alarm 1 output only. Also, the alarm 4 only can be assigned to the control output relay (if a relay is not used for control output).

● Display and Operation Functions

PV Display

PV is displayed in the 5-digit display. PV1 or PV2 is displayed by switching them in cascade control. The number of display digits is 4 or 5. For thermocouple or RTD, data below the decimal point can be set not to display. The display range is -19999 to 30000 and the display span is 30000 or less.

Setpoint Display

A parameter name is displayed in the 3-digit display and data in the 5-digit display. There are four kinds of displays : operating display, operating parameter setting display, setup parameter setting display and SELECT display.

Operating display:
Data necessary for operations, such as setpoint or control output, are displayed depending on the UT mode.

Operating parameters setting display:
The Operating parameters, which are mainly changed during operations, such as PID constant, are displayed.

Setup parameters setting display:
The Setup parameters to configure the functions of the instrument before starting operation are displayed.
UT mode is to be set in this display.

SELECT display:
Up to five displays which are frequently accessed can be selected from the Operating parameters setting display and Setup parameters setting display to be displayed in the SELECT display.

Status Indicator Lamps

Alarm indicator lamps:
Four lamps, AL1, AL2, AL3, and AL4

Status indicator lamps:
REM (remote operation), MAN (manual mode operation), CAS (cascade operation), and LP2 (cascade secondary-loop control)

Deviation monitor:
▲Plus deviation, ▼Minus deviation, and ■ deviation in normal range

PV display color changing function "Active Color PV Display"

(Factory-set default : Fixed in red mode)
This function automatically changes PV display color by the action described below. Green-to-red or red-to-green changing action is selectable.

Link to alarm 1 mode :
Alarm OFF : green, Alarm ON : red
Setting of Alarm OFF : red, Alarm ON : green is possible.

Link to alarm 1 and 2 mode :
Alarm OFF : green, Alarm ON : red
Setting of Alarm OFF : red, Alarm ON : green is possible.

SP deviation mode :
Within the preset SP deviation : green,
Out of the preset SP deviation : red
Setting of within the preset SP deviation : red,
Out of the preset SP deviation : green is possible.
Deviation band is changeable using a parameter. The setting of either high limit deviation or low limit deviation is also possible.

PV limit mode :
Within the preset PV range : green,
Out of the preset PV range : red
Setting of within the preset PV range : red,
Out of the preset PV range : green is possible.
The range (high limit and low limit) is changeable using a parameter.

Fixed color mode :
PV display color is fixed in green or red.

Operation Keys

△, ▽ keys: Increase or decrease setpoints and other parameters displayed in the setpoint display.
SET/ENT key: Used for setting or changing set data, switching the displayed contents, and switching operation modes except for A/M.
A/M key: Operation mode switching (Auto/Manual)

Security Function

Key-lock by parameter setting and prohibiting operation by a password are available.

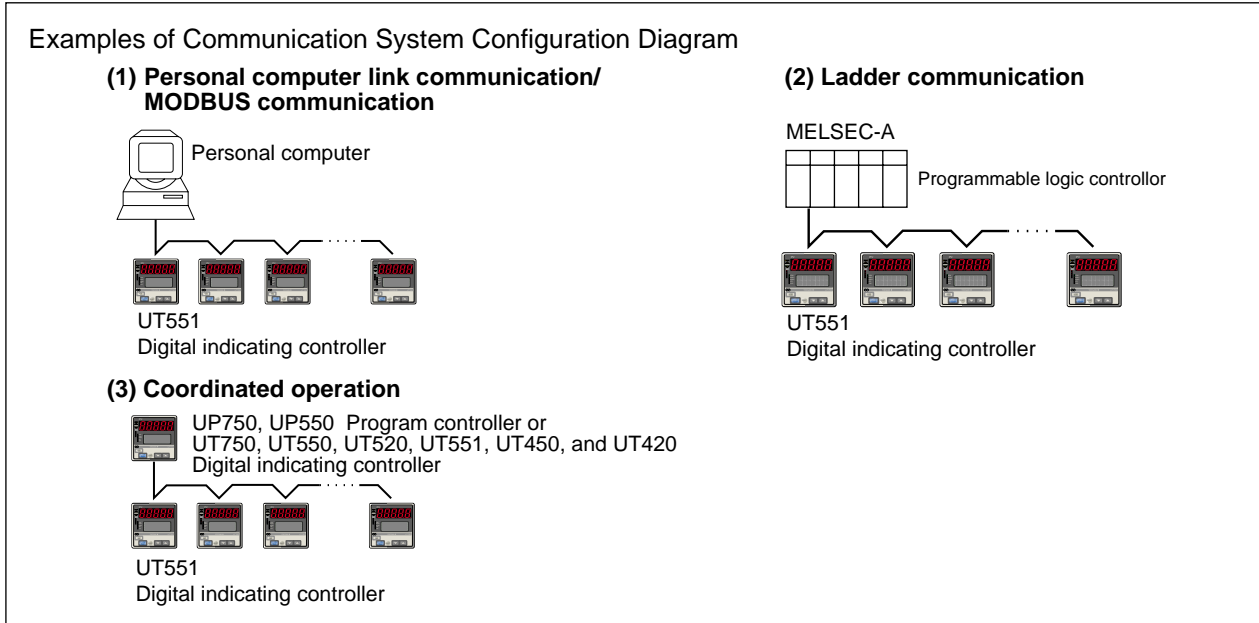

● **Communication Functions**

(For optional function code □1 or □2 only)
This controller has four types of communication protocol with one communication interface. Communication is possible with personal computer, programmable logic controller, and other controllers.

Communication Protocol

- Computer link communication:
Communication protocol with a personal computer
- Ladder communication:
Communication protocol with the ladder program on some programmable logic controllers.
- Coordinated operation:
Protocol for coordinated operation with more than one GREEN Series controller. The UT551 controller can be connected as a master or slave station.

MODBUS communication:
Communication protocol with a personal computer, or PLC.

RS-485 Communication Interface

The RS-485 communication interface (conforms to EIA RS485) can be used for personal computer link, MODBUS communication, ladder communication, or for coordinated operation.

- Maximum number of connectable controllers:
31 GREEN Series controllers
- Maximum communication distance: 1200 m
- Communication method:
Two-wire half-duplex or four-wire half-duplex, start-stop synchronization, and non-procedural
- Baud rate:
600, 1200, 2400, 4800, or 9600 bps

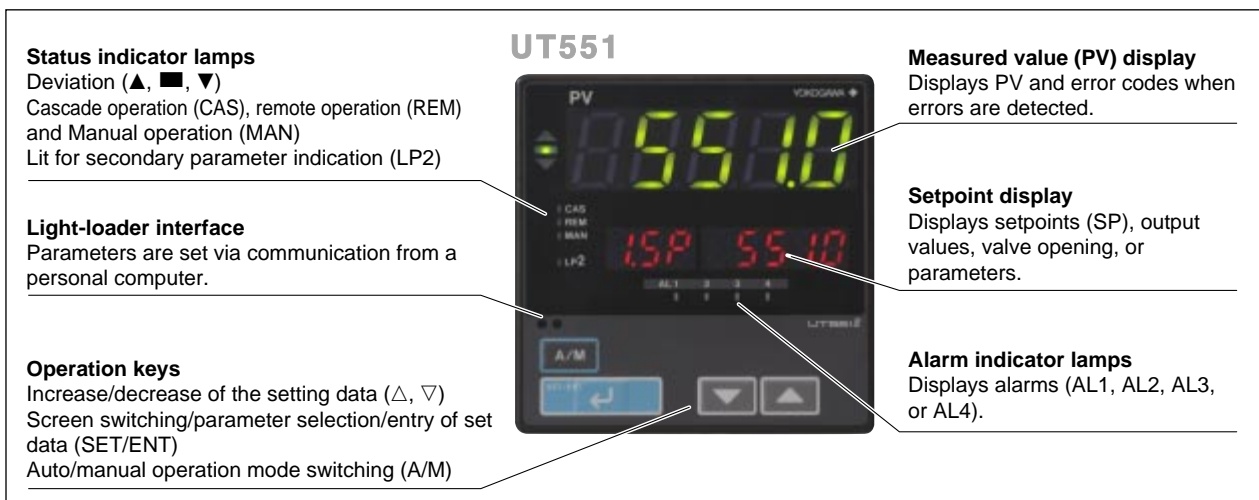

■ Hardware Specifications

● Input/Output Signal Specifications

PV Input Signal

Number of input points: 1

Input type, instrument input range, and measurement accuracy:

The type of input and instrument input range can be specified from the instrument input range codes shown in the table below.

Sampling period: 50, 100, 200, or 500 ms (selectable)

Burnout detection:

Activated for thermocouple (TC) input, RTD input, or standard signal of 0.4 to 2 V DC or 1 to 5 V DC.

Possible to specify a travel of upscale, downscale, or off.

For standard signal input, set to burnout at 0.1 V or less.

Input bias current: 0.05 μ A (for TC or RTD b-terminal)

Measurement current(RTD): About 0.13 mA

Input resistance: 1 M Ω or more for TC or mV input
About 1 M Ω for DC voltage input

Allowable signal source resistance:

250 Ω or less for TC or mV input

Signal source resistance effect

0.1 μ V/ Ω or less

2 k Ω or less for DC voltage input

Signal source resistance effect

About 0.01%/100 Ω

Allowable wiring resistance (for RTD input):

Maximum 150 Ω /wire (Conductor resistance between three wires must be equal.)

However, it must be 10 Ω /wire for a maximum range of -150.0 to 150.0 $^{\circ}$ C.

Effect of wiring resistance: $\pm 0.1^{\circ}$ C/10 Ω

Allowable input voltage:

± 10 V DC for TC/mV/RTD input

± 20 V DC for DC voltage input

Noise rejection ratio:

Normal mode 40 dB (50/60 Hz) or more

Common mode 120 dB (50/60 Hz) or more

Reference junction compensation error:

$\pm 1.0^{\circ}$ C (15 to 35 $^{\circ}$ C), $\pm 1.5^{\circ}$ C (0 to 15 $^{\circ}$ C and 35 to 50 $^{\circ}$ C)

Applicable standards:

JIS, IEC, and DIN (ITS-90) for TC and RTD

Input Type	Instrument Input Range Code	Instrument Input Range ($^{\circ}$ C)	Instrument Input Range ($^{\circ}$ F)	Measurement Accuracy*1		
Unspecified (When shipped from the factory)		OFF	Set the data item PV input type "IN 1" to the OFF option to leave the PV input type undefined.			
Thermocouple	K	1	-270.0 to 1370.0 $^{\circ}$ C	-450.0 to 2500.0 $^{\circ}$ F	$\pm 0.1\%$ ± 1 digit of instrument range at 0 $^{\circ}$ C or more $\pm 0.2\%$ ± 1 digit of instrument range at less than 0 $^{\circ}$ C • However, $\pm 2\%$ ± 1 digit of instrument range for type K at temperatures less than -200 $^{\circ}$ C. • However, $\pm 1\%$ ± 1 digit of instrument range for type T at temperatures less than -200 $^{\circ}$ C.	
		2	-270.0 to 1000.0 $^{\circ}$ C	-450.0 to 2300.0 $^{\circ}$ F		
		3	-200.0 to 500.0 $^{\circ}$ C	-200.0 to 1000.0 $^{\circ}$ F		
	J	4	-200.0 to 1200.0 $^{\circ}$ C	-300.0 to 2300.0 $^{\circ}$ F		
	T	5	-270.0 to 400.0 $^{\circ}$ C	-450.0 to 750.0 $^{\circ}$ F		
		6	0.0 to 400.0 $^{\circ}$ C	-200.0 to 750.0 $^{\circ}$ F		
	B	7	0.0 to 1800.0 $^{\circ}$ C	32 to 3300 $^{\circ}$ F		$\pm 0.15\%$ ± 1 digit of instrument range at 400 $^{\circ}$ C or more $\pm 5\%$ ± 1 digit of instrument range at less than 400 $^{\circ}$ C
	S	8	0.0 to 1700.0 $^{\circ}$ C	32 to 3100 $^{\circ}$ F		$\pm 0.15\%$ ± 1 digit of instrument range
	R	9	0.0 to 1700.0 $^{\circ}$ C	32 to 3100 $^{\circ}$ F		$\pm 0.15\%$ ± 1 digit of instrument range
	N	10	-200.0 to 1300.0 $^{\circ}$ C	-300.0 to 2400.0 $^{\circ}$ F		$\pm 0.1\%$ ± 1 digit of instrument range $\pm 0.25\%$ ± 1 digit of instrument range for temperature at less than 0 $^{\circ}$ C
	E	11	-270.0 to 1000.0 $^{\circ}$ C	-450.0 to 1800.0 $^{\circ}$ F		$\pm 0.1\%$ ± 1 digit of instrument range at 0 $^{\circ}$ C or more $\pm 0.2\%$ ± 1 digit of instrument range at less than 0 $^{\circ}$ C • However, $\pm 1.5\%$ ± 1 digit of instrument range for type E at temperature less than -200 $^{\circ}$ C.
	L (DIN)	12	-200.0 to 900.0 $^{\circ}$ C	-300.0 to 1600.0 $^{\circ}$ F		$\pm 0.2\%$ ± 1 digit of instrument range
	U (DIN)	13	-200.0 to 400.0 $^{\circ}$ C	-300.0 to 750.0 $^{\circ}$ F		
	W (DIN)	14	0.0 to 400.0 $^{\circ}$ C	-200.0 to 1000.0 $^{\circ}$ F		$\pm 0.2\%$ ± 1 digit of instrument range
0.0 to 2300.0 $^{\circ}$ C			32 to 4200 $^{\circ}$ F			
Platinel 2	16	0.0 to 1390.0 $^{\circ}$ C	32.0 to 2500.0 $^{\circ}$ F	$\pm 0.1\%$ ± 1 digit of instrument range		
PR20-40	17	0.0 to 1900.0 $^{\circ}$ C	32 to 3400 $^{\circ}$ F	$\pm 0.5\%$ ± 1 digit of instrument range at 800 $^{\circ}$ C or more Accuracy not guaranteed for temperature less than 800 $^{\circ}$ C		
W97Re3-W75Re25		0.0 to 2000.0 $^{\circ}$ C	32 to 3600 $^{\circ}$ F			
RTD	JPt100	30	-200.0 to 500.0 $^{\circ}$ C	-300.0 to 1000.0 $^{\circ}$ F	$\pm 0.1\%$ ± 1 digit of instrument range (Note 1) (Note 2)	
		31	-150.00 to 150.00 $^{\circ}$ C	-200.0 to 300.0 $^{\circ}$ F	$\pm 0.2\%$ ± 1 digit of instrument range (Note 1)	
	Pt100	35	-200.0 to 850.0 $^{\circ}$ C	-300.0 to 1560.0 $^{\circ}$ F	$\pm 0.1\%$ ± 1 digit of instrument range (Note 1) (Note 2)	
		36	-200.0 to 500.0 $^{\circ}$ C	-300.0 to 1000.0 $^{\circ}$ F	$\pm 0.1\%$ ± 1 digit of instrument range (Note 1)	
		37	-150.00 to 150.00 $^{\circ}$ C	-200.0 to 300.0 $^{\circ}$ F		
Standard signal	0.4 to 2V	40	0.400 to 2.000 V	Display range -19999 to 30000 Display span 30000 or less (Decimal point position changeable)	$\pm 0.1\%$ ± 1 digit of instrument range	
	1 to 5V	41	1.000 to 5.000 V			
DC voltage	0 to 2V	50	0.000 to 2.000 V			
	0 to 10V	51	0.00 to 10.00 V			
	-10 to 20mV	55	-10.00 to 20.00 mV			
	0 to 100mV	56	0.0 to 100.0 mV			

Note 1: The accuracy is $\pm 0.3^{\circ}$ C of instrument range ± 1 digit for a temperature range from 0 to 100 $^{\circ}$ C.

Note 2: The accuracy is $\pm 0.5^{\circ}$ C of instrument range ± 1 digit for a temperature range from -100 to 200 $^{\circ}$ C.

*1: Performance in the standard operating conditions (at 23 $\pm 2^{\circ}$ C, 55 $\pm 10\%$ RH, and 50/60Hz power frequency)

*2: When receiving 4 to 20mA DC current signals, select a standard signal 1 to 5V DC and connect a 250 ohm resistor (option).

Model: X010-250-2 (resistor with M3.5 crimp-on terminal lugs)

Auxiliary Analog Input Signal

(UT551-□1, -□2, or -□4 only)
 Functions: Remote setting input, tracking input, cascade control secondary loop PV input, etc.
 Input type: Settable within the range of voltage input 0 to 2 V DC, 0 to 10 V DC, 0.4 to 2.0 V DC or 1 to 5 V DC.
 Number of inputs: 1 point
 Sampling period: 100, 200 or 500 ms
 Auxiliary analog input sampling period is linked with PV input sampling period.
 (If PV input period is 50 ms, auxiliary analog input period is 100 ms.)
 Input resistance: Approx. 1 MΩ
 Input accuracy: ±0.3% ± 1 digit of input span for 0 to 2 V DC input
 ±0.2% ± 1 digit of input span for 0 to 10 V DC input
 ±0.375% ± 1 digit of input span for 0.4 to 2.0 V DC range
 ±0.3% ± 1 digit of input span for 1 to 5 V DC range
 Performance in the standard operating conditions (at 23±2°C, 55±10% RH, and 50/60Hz power frequency)

Feedback Resistance Input Signal

(UT551-1□ and -4□ only) Valid for position proportional PID control.
 Slidewire resistance:
 Total resistance 100 Ω to 2.5 kΩ (with burnout detection of slidewire)
 Measuring resolution ±0.1% of total resistance

24 V DC Loop Power Supply for Sensor

(UT551-3□ and -4□ only)
 Supplies power to the 2-wire transmitter. The current signal is converted to a voltage signal by placing a resistor (arbitrary from 10 to 250 Ω) and is read by the PV input terminal.
 21.6 to 28.0 V DC, maximum supply current about 30 mA (only for models with 24 V DC loop power supply for sensor).

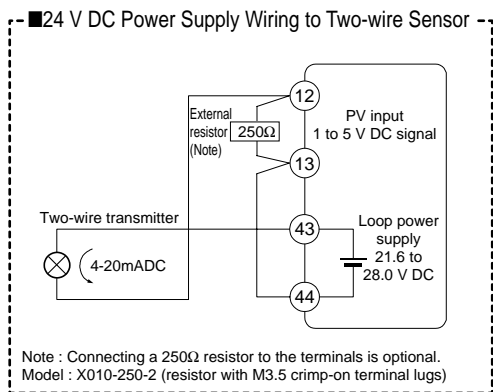

Retransmission Output

Any of the PV, target setpoint or control output is output.
 Or this can be used for 15 V DC loop power supply.
 Number of output points: 1 or 2
 Retransmission output 2 is available only when "relay" is selected as the control output type.
 Output signal: 4 to 20 mA DC, 0 to 20 mA DC, 20 to 4 mA DC or 20 to 0 mA DC (0 mA or less cannot be output)

Load resistance: 600 Ω or less
 Output accuracy: ±0.1% of span (±5% for 1 mA or less)
 Performance in the standard operating conditions (at 23±2°C, 55±10% RH, and 50/60Hz power frequency)
 When using for 15 V DC loop power supply:
 Supply voltage 14.5 to 18.0 V DC, maximum supply current about 21 mA (with the protection circuit at field short-circuit).

Control Outputs

Select 1 or 2 points (UT551-2□) from the following output types depending on model type and UT mode. Relay contact output for position proportional PID control (UT551-1□ and UT551-4□).

Current output

Number of output points: 1 or 2 (for heating/cooling type) (switchable to voltage pulse output)
 Output signal: 4 to 20 mA DC, 0 to 20 mA DC, 20 to 4 mA DC or 20 to 0 mA DC
 Load resistance: 600 Ω or less
 Output accuracy:
 ±0.1% of span (±5% for 1 mA or less)
 Performance in the standard operating conditions (at 23±2°C, 55±10% RH, and 50/60Hz power frequency)

Voltage pulse output

Number of output points: 1 or 2 (for heating/cooling control) (switchable to current output)
 Output signal:
 ON voltage-12 V DC or more (load resistance 600 Ω or more)
 OFF voltage- 0.1 V DC or less
 Resolution: 10 ms or 0.1% of output value, whichever is greater

Relay contact output

Number of output points: 1 or 2 (for heating/cooling control)
 Output signal: At three terminals of NC, NO, and Common
 Contact rating: 250 V AC, 3 A or 30 V DC, 3 A (resistance load)
 Resolution: 10 ms or 0.1% of output value, whichever is greater

Contact Inputs

Usage: Target setpoint switching, C/A/M mode switching, REMOTE/LOCAL switching, RUN/STOP switching, or PV input switching

Number of input points:

Varies with optional function codes (as shown below):
 UT551-□0: 2 points
 UT551-□1: 8 points
 UT551-□2: 3 points
 UT551-□3: 7 points
 UT551-□4: 3 points

Input type: Non-voltage contact input or transistor open collector input

Input contact rating: 12 V DC, 10 mA or more

On/off detection:

For non-voltage contact input,
 On .. contact resistance 1 kΩ or less;
 Off.. contact resistance 20 kΩ or more
 For transistor contact input,
 On .. 2 V or less;
 Off.. leak current 100 μA or less
 Minimum status detection hold time: PV input sampling period ×3

Contact Outputs

Usage: Alarm output, FAIL output

Number of output points:

Varies with optional function codes (as shown below):

UT551-□0: Relay output 3 points

UT551-□1: Relay output 3 points, transistor output 4 points

UT551-□2: Relay output 3 points

UT551-□3: Relay output 3 points, transistor output 4 points

UT551-□4: Relay output 3 points

However, when a relay is not used for control output, the relay for control output can be used for the alarm 4. For this reason, the number of relay output points can be changed to 4 by adding to the above 3.

Relay contact rating: 240 V AC, 1 A or 30 V DC, 1 A, normally open (COM terminal is common for every contact output)

(Normally close for FAIL output)

Transistor contact rating: 24 V DC, 50 mA

● Display Specifications

Measured value (PV) display:

5-digit 7-segment green or red color LED display; height of letters 20 mm

Data display: 3 digits + 5 digits, 7-segment red color LED display; height of letters 9.3 mm

Status indicator lamps: LEDs

● Conformance to Safety and EMC Standards

Safety: Complies with IEC/EN61010-1 (CE), approved by C22.2 No.61010-1, approved by UL508.

Installation category : CAT. II Pollution degree: 2 (IEC/EN61010-1, C22.2 No.61010-1)

Measurement category : I (CAT. I : IEC/EN61010-1)

Rated measurement input voltage : 10V DC max.(across terminals), 300V AC max.(across ground)

Rated transient overvoltage : 1500V (Note)

Note : It is a value on the safety standard which is assumed by IEC/EN61010-1 in Measurement category I, and is not the value which guarantees an apparatus performance.

EMC standards: Complies with EN61326, EN61000-3-2, EN61000-3-3 and EN55011 (CE). AS/NZS 2064 compliant (C-Tick).

Class A Group 1.

During test, the controller continues to operate with the measurement accuracy within $\pm 20\%$ of the range.

● Construction, Installation, and Wiring

Construction: Dust-proof and Drip-proof front panel conforming to IP55.

For side-by-side close installation, the controller loses its dust-proof and drip-proof protection.

Material of the body: ABS resin and polycarbonate

Case color: Black

Weight: About 1 kg or less

External dimensions: 96W \times 96H \times 100D (from the panel face) (mm)

Mounting: Direct panel mounting; mounting bracket, one each for upper and lower mounting

Panel cutout dimensions: $92^{+0.8}_0$ W \times $92^{+0.8}_0$ H (mm)

Mounting attitude:

Up to 30 degrees from horizontal; Must not face downward.

Wiring connection:

With M3.5 screw terminals (for signal, power and grounding wiring)

● Power Supply and Isolation

Power supply: Rated voltage 100 to 240 V AC ($\pm 10\%$), 50/60 Hz

Power consumption: Max. 20 VA (Max. 8.0 W)

Internal fuse rating: 250 V AC, 1.6 A time-lag fuse

Data backup: Non-volatile memory. Service life about 100,000 times of writings

Withstanding voltage:

1500 V AC for 1 min.

between primary terminals and secondary terminals

1500 V AC for 1 min.

between primary terminals and ground terminal

1500 V AC for 1 min.

between ground terminal and secondary terminals

500 V AC for 1 min.

between secondary terminals

(where primary terminals stand for power and relay output terminals and secondary terminals stand for analog input and output signal terminals, voltage pulse output terminals, and contact input terminals.)

Isolation resistance:

20 M Ω or more for 500 V DC applied

between power terminals and ground terminal

Grounding: Class D grounding (grounding resistance of 100 Ω or less)

Isolation Specifications

PV input terminal:

Isolated from other input/output terminals, but not isolated from internal circuit.

Auxiliary analog input terminal:

Isolated from other input/output terminals and internal circuit.

15 V DC loop power supply terminal:

Not isolated from analog current output and voltage pulse control output, but isolated from other input/output terminals and internal circuit.

24 V DC loop power supply terminal:

Isolated from 4-20mA analog output, other input/output terminals and internal circuit.

Control output (current output or voltage pulse output) and retransmission output: Not isolated between control output and retransmission output, but isolated from other input/output terminals and internal circuit.

Relay contact control output terminals:

Isolated between contact output terminals, and from other input/output terminals and internal circuit.

Contact input terminals:

Not isolated between contact input terminals and from communication terminals, but isolated from other input/output terminals and internal circuit.

- Relay contact output terminals:
Not isolated between relay contact outputs, but isolated from other input/output terminals and internal circuit.
- Transistor contact output terminals:
Not isolated between transistor contact outputs, but isolated from other input/output terminals and internal circuit.
- RS-485 communication terminals:
Not isolated from contact input terminals, but isolated from other input/output terminals and internal circuit.
- Feedback slidewire resistance input terminals:
Not isolated from control output terminals (current or voltage pulse output) and retransmission output, but isolated from other input/output terminals and internal circuit.
- Power terminals:
Isolated from other input/output terminals and internal circuit.
- Ground terminal:
Isolated from other input/output terminals and internal circuit.

● Environmental Conditions

- Normal operating conditions:
- Ambient temperature: 0 to 50°C (40°C or less for side-by-side close mounting)
 - Temperature change rate limit: 10°C/h or less
 - Ambient humidity: 20 to 90% RH (no condensation)
 - Magnetic field: 400 A/m or less
 - Continuous vibration (5 to 14 Hz):
Peak-to-peak amplitude 1.2 mm or less
 - Continuous vibration (14 to 150 Hz):
4.9 m/s² or less
 - Short-period vibration: 14.7 m/s², 15 s or less
 - Shock: 147 m/s² or less, 11 ms
 - Installation altitude: 2000 m or less above sea level
 - Warm-up time: 30minutes or more after power on
- Transportation and storage conditions:
- Temperature: -25 to 70°C
 - Temperature change rate: 20°C/h or less
 - Humidity: 5 to 95% RH (no condensation)
- Effects of operating conditions
- Effect of ambient temperature:
- Whichever is greater, $\pm 1 \mu\text{V}/^\circ\text{C}$ or $\pm 0.01\%$ of F.S./°C for voltage or thermocouple inputs.
 - $\pm 0.02\%$ of F.S./°C for Auxiliary input
 - $\pm 0.05^\circ\text{C}/^\circ\text{C}$ (ambient temperature) or less for RTD inputs.
 - $\pm 0.05\%$ of F.S./°C or less for analog outputs.
- Effect of power supply fluctuation (within rated voltage range):
- Whichever is greater, $\pm 1 \mu\text{V}/10 \text{ V}$ or $\pm 0.01\%$ of F.S./10 V for analog inputs.
 - $\pm 0.05\%$ of F.S./10 V or less for analog outputs.

Function Block Diagram for Single-loop Control (Model UT551-0□ ,UT551-2□ or UT551-3□)

(See the User's Manual (Reference) (CD-ROM) for Function Block Diagrams for other modes.)

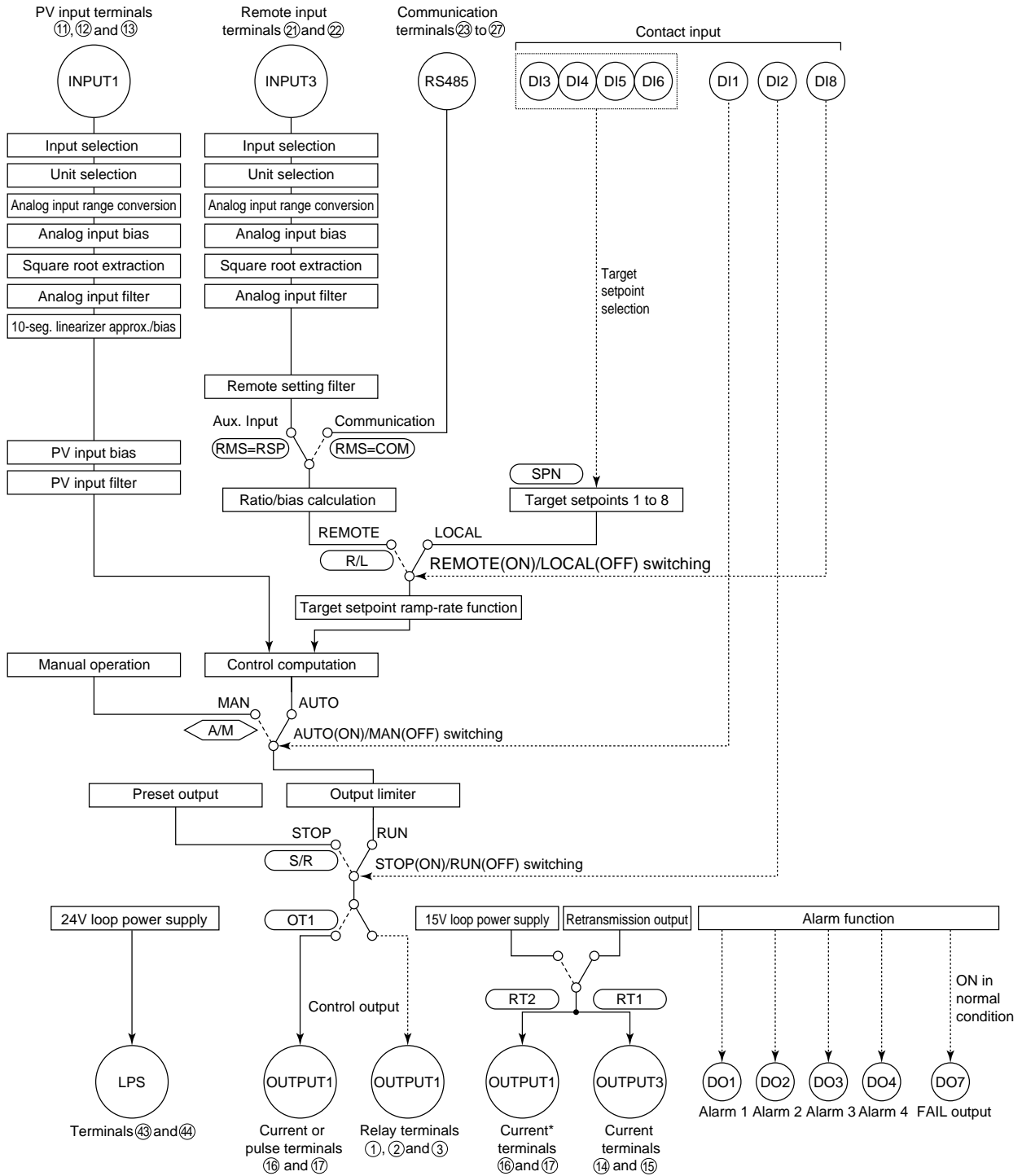

* Unavailable when control output is current or pulse.

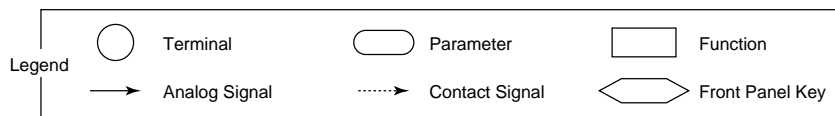

■ Function Block Diagram for Single-loop Heating/Cooling Control (Model UT551-2□)

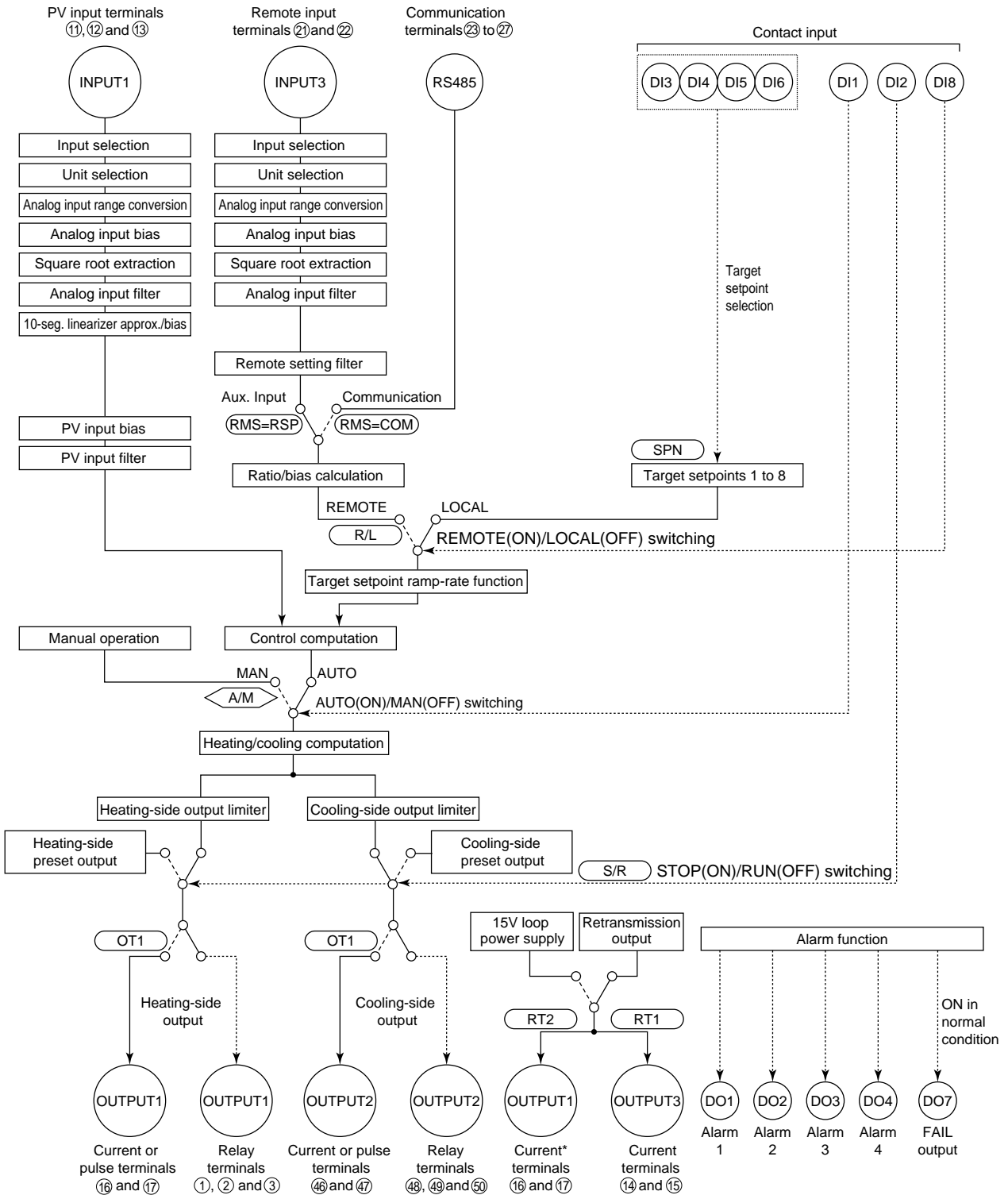

* Unavailable when heating-side output is current output or pulse.

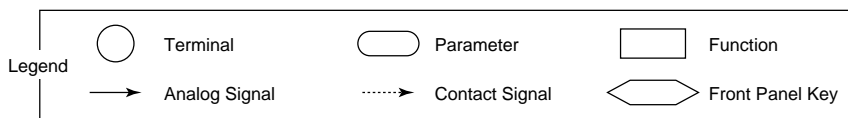

Function Block Diagram for Single-loop Position-proportional Control (Model UT551-1□ or UT551-4□)

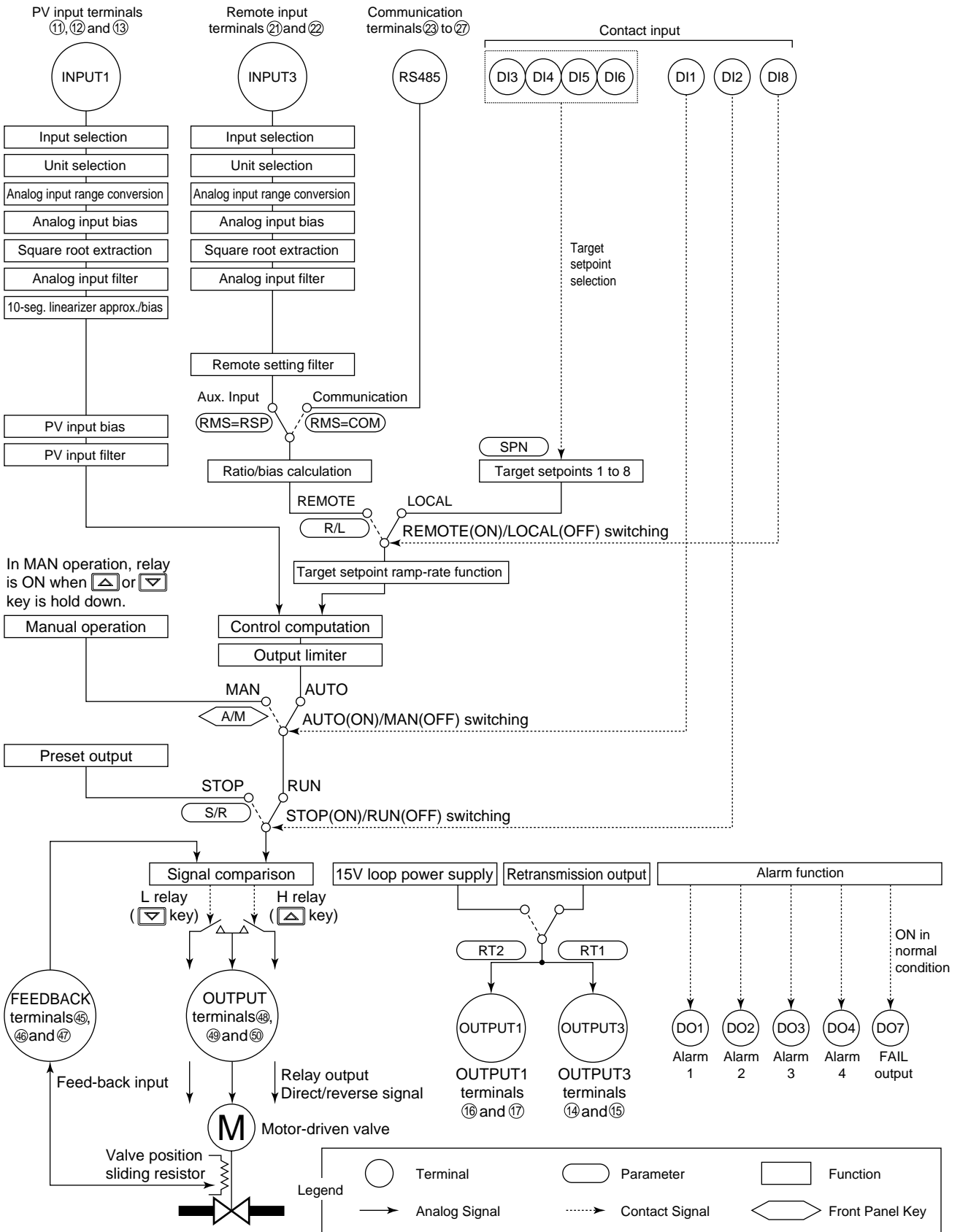

④③ - ④④ terminals : 24VDC loop power supply

Function Block Diagram for Cascade Control

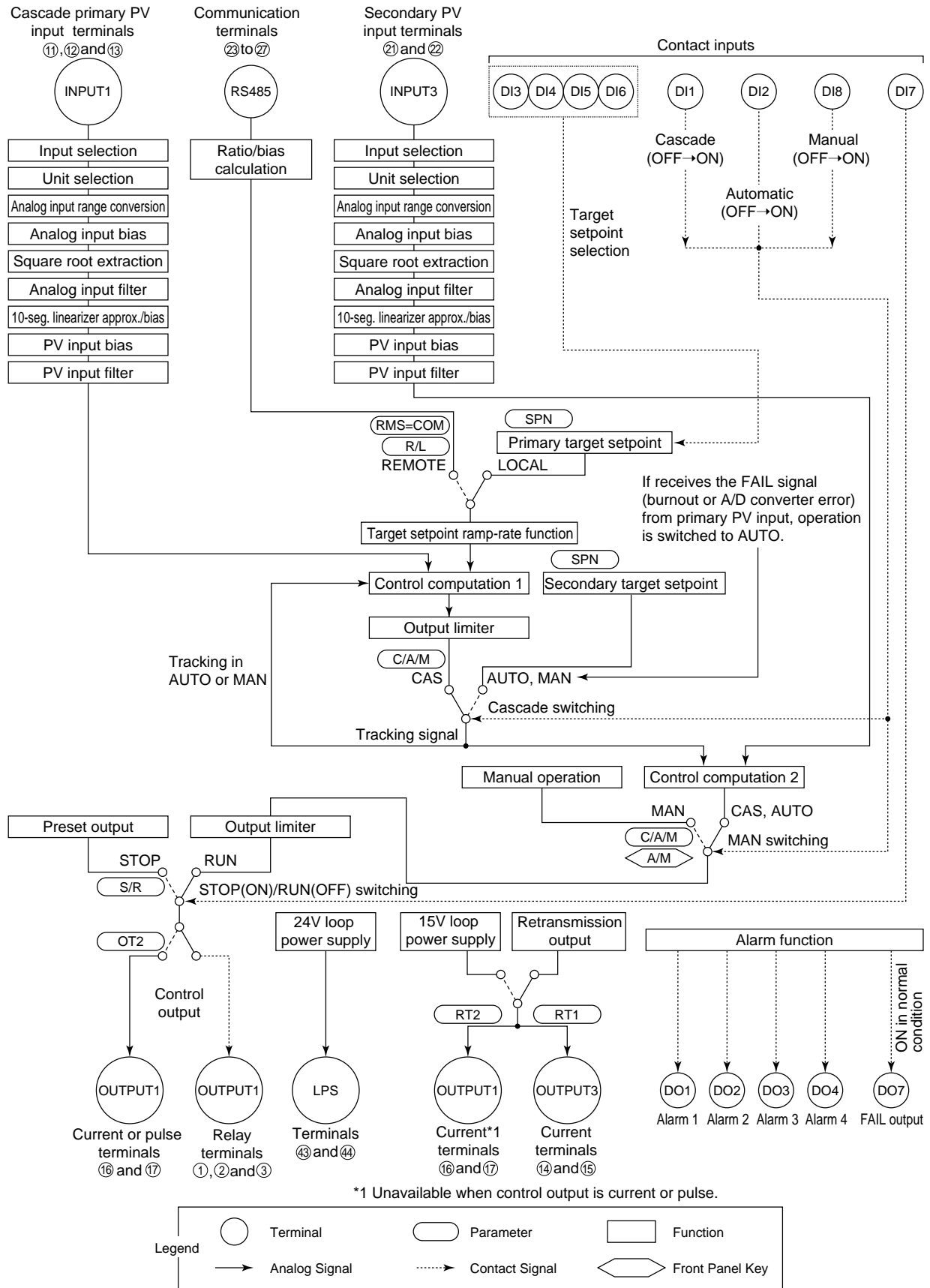

Function Block Diagram for Loop Control for Backup

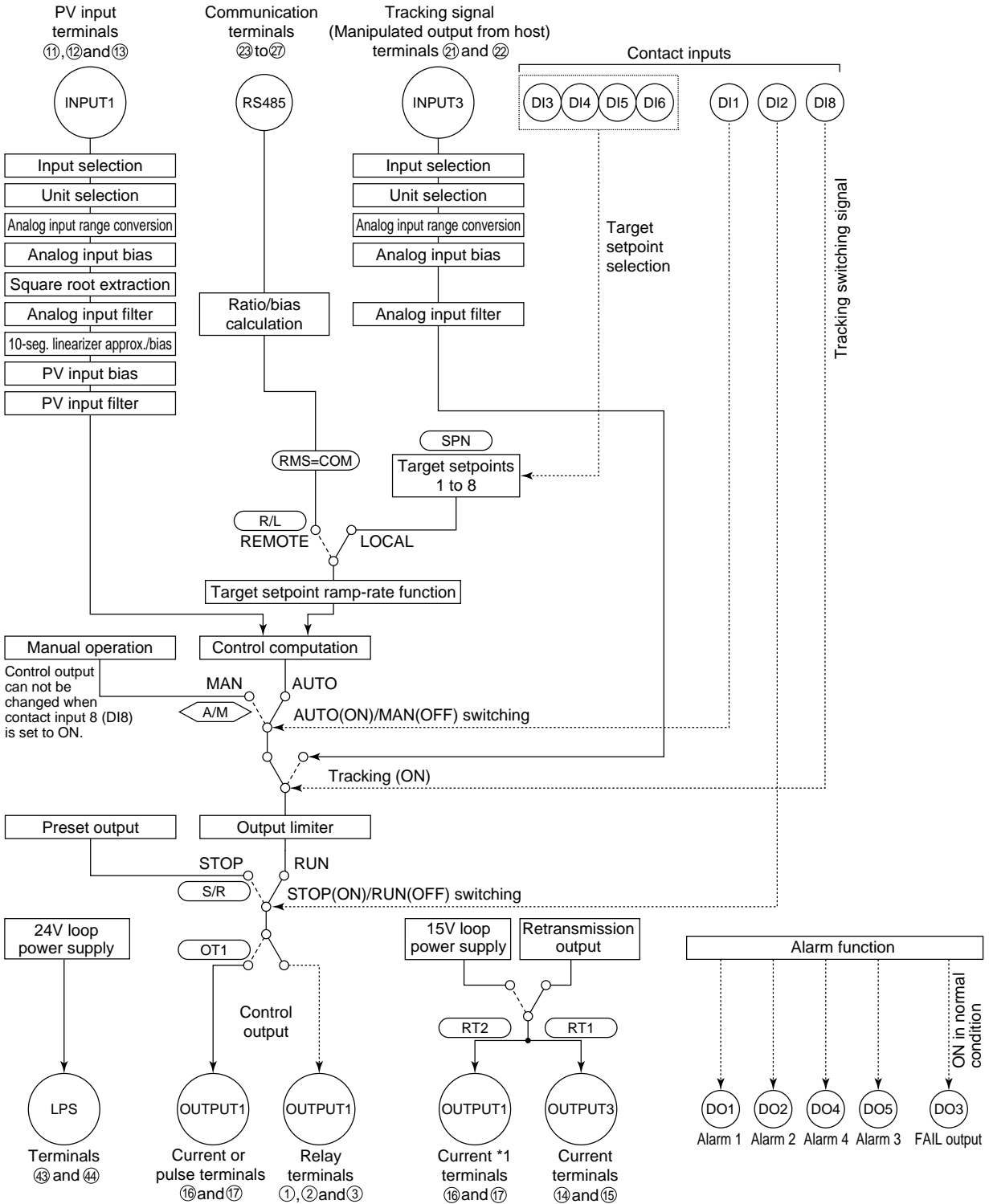

*1 Unavailable when control output is current or pulse.

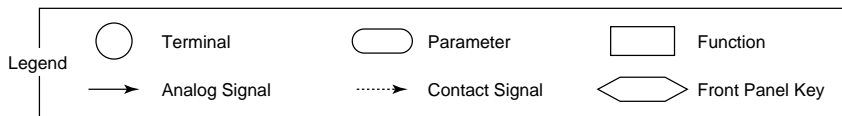

Function Block Diagram for Loop Control with PV Switching

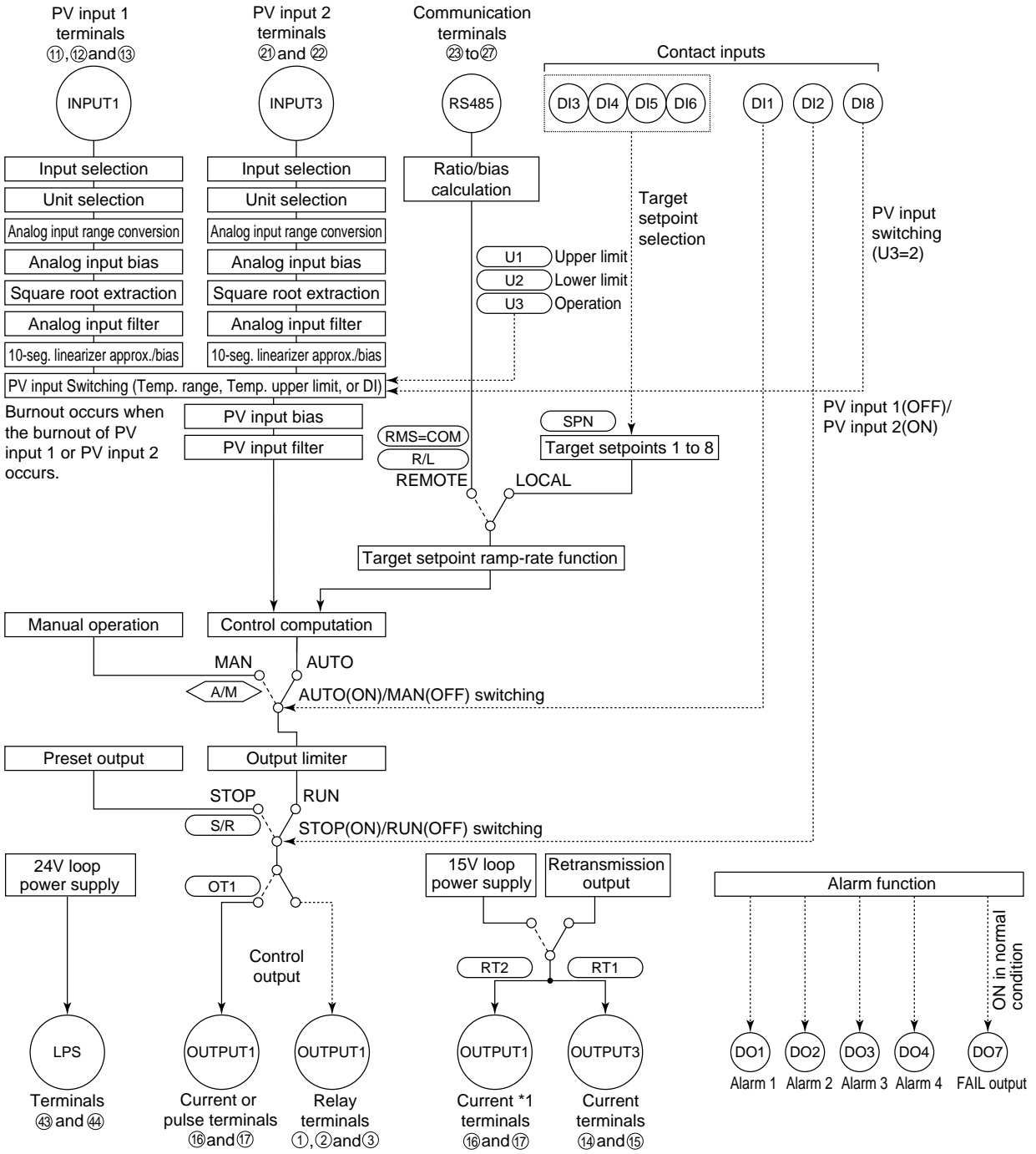

*1 Unavailable when control output is current or pulse.

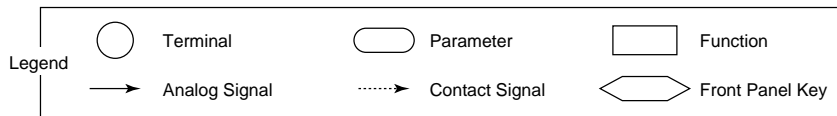

UT551 Single-loop Control (Model UT551-0□, UT551-2□ or UT551-3□), Terminal Arrangements

See the User's Manual (Reference) (CD-ROM version) for the terminal arrangements not described in this document.

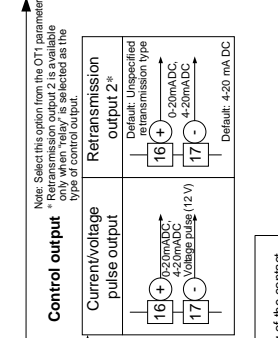
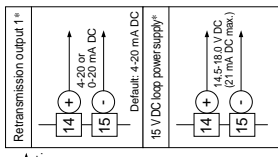
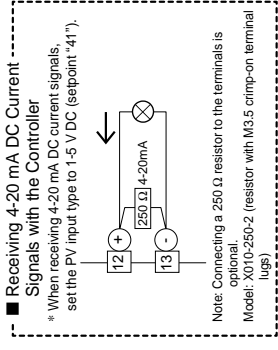
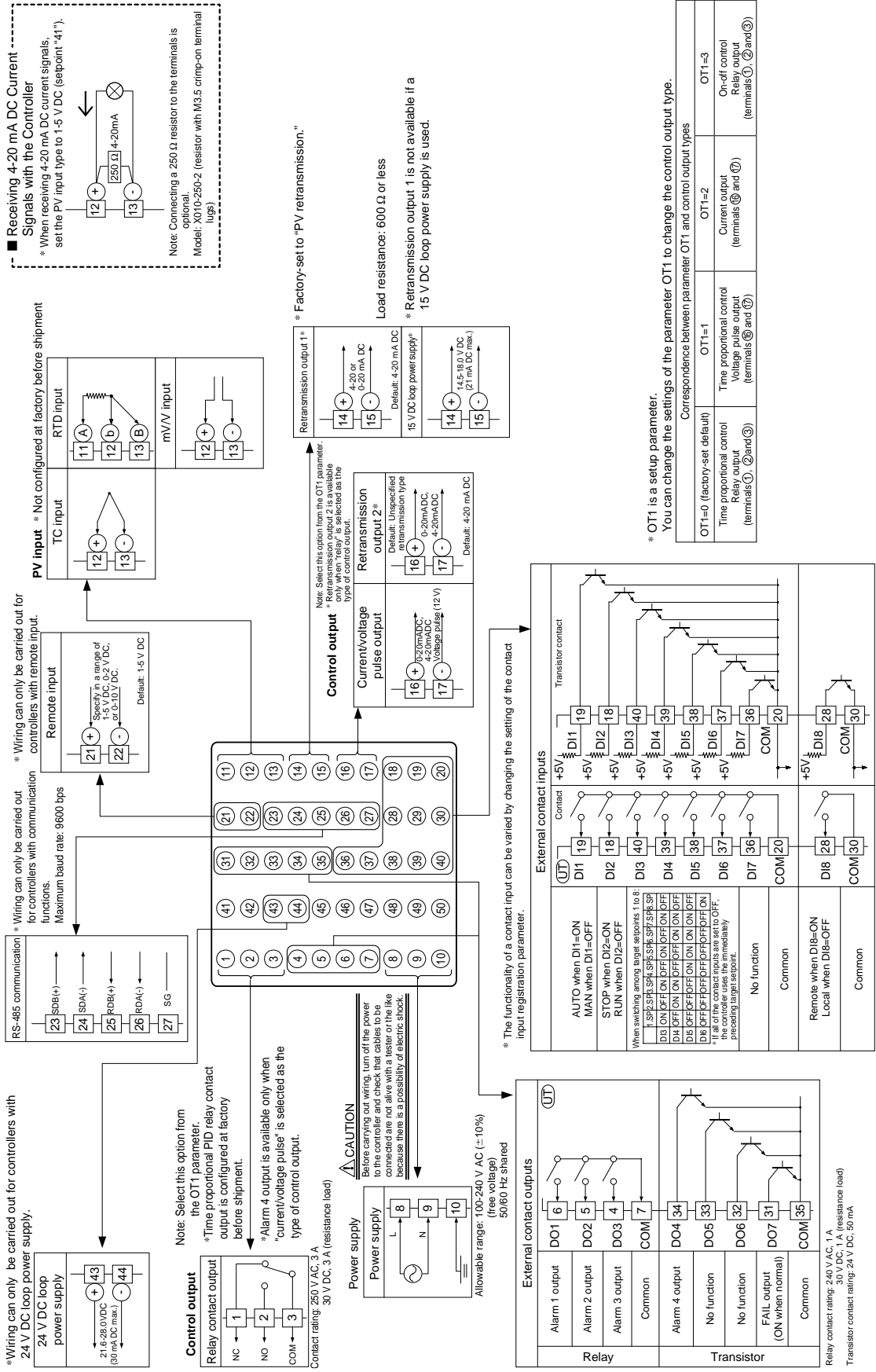

* OT1 is a setup parameter.
 You can change the settings of the parameter OT1 to change the control output type.

Correspondence between parameter OT1 and control output types

OT1=0 (factory-set default)	OT1=1	OT1=2	OT1=3
Time proportional control Relay output (terminals ①, ② and ③)	Time proportional control Voltage pulse output (terminals ⑥ and ⑦)	Current output (terminals ⑥ and ⑦)	On-off control Relay output (terminals ①, ② and ③)

UT551 Single-loop Heating/Cooling Control (Model UT551-2□), Terminal Arrangements

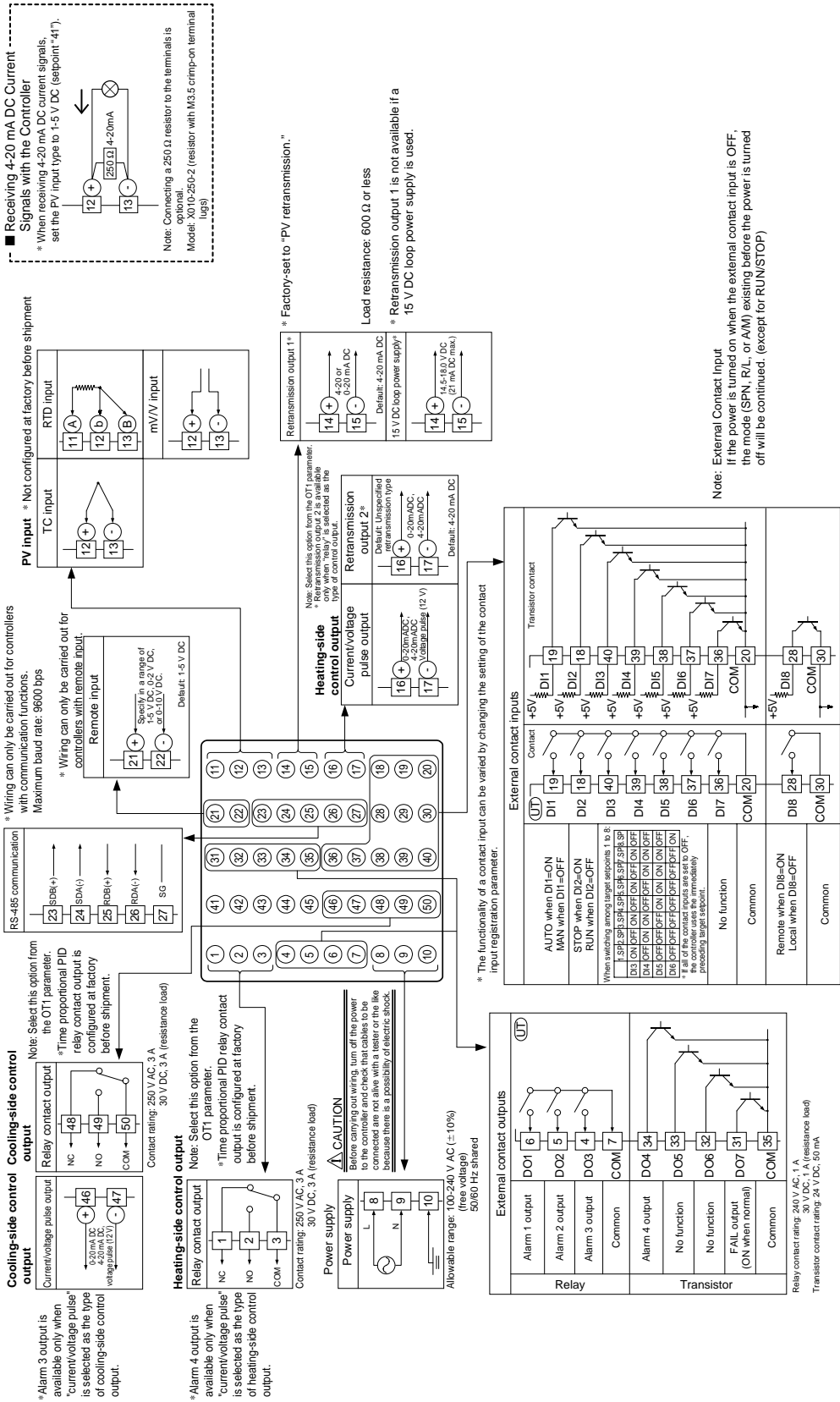

* OT1 is a setup parameter. You can change the settings of the parameter OT1 to change the control output type.

The types of control output, "relay output" and "voltage pulse output" shown in the table above refer to those of time proportional control. To change to a relay output for on-off control, select "Relay Terminals" and change the setpoint of the proportional band to "0".

Note: External Contact Input
If the power is turned on when the external contact input is OFF, the mode (SPN, RL, or AM) existing before the power is turned off will be continued. (except for RUN/STOP)

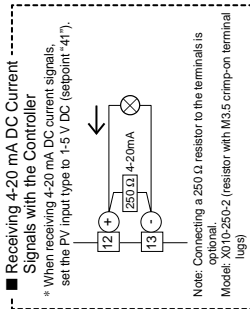

* Factory-set to "PV retransmission."

Load resistance: 600 Ω or less

* Retransmission output 1 is not available if a 15 V DC loop power supply is used.

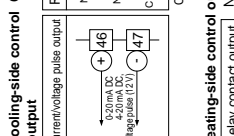
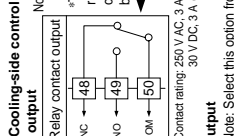
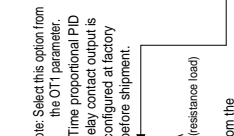
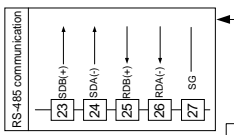
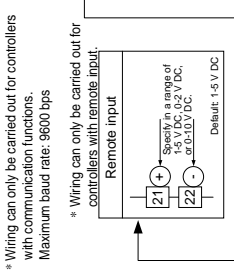
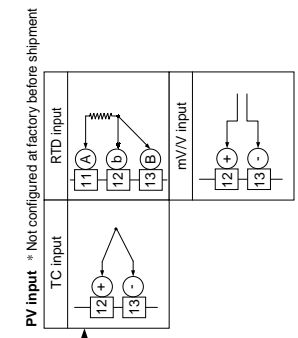
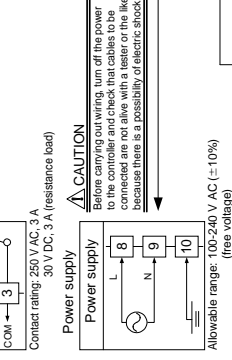
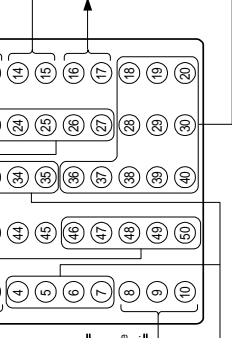
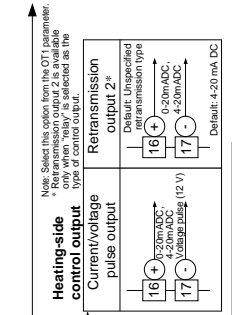
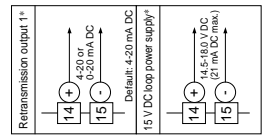

UT551 Single-loop Position Proportional Control (Model UT551-1□ or UT551-4□), Terminal Arrangements

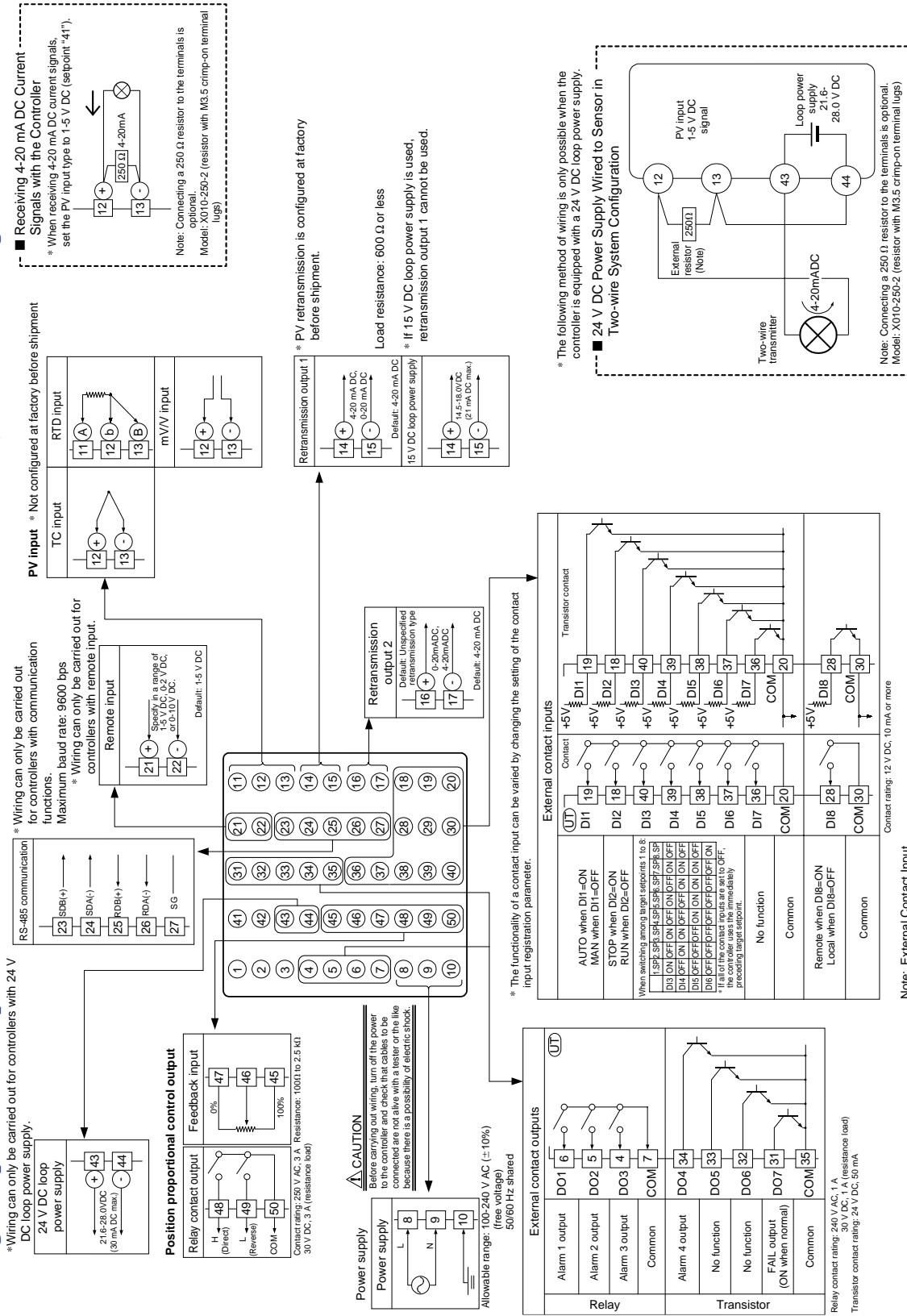

UT551 Cascade Control, Terminal Arrangements

*Wiring can only be carried out for controllers with 24 V DC loop power supply.

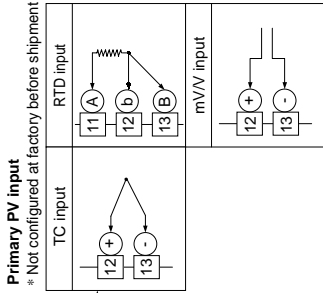
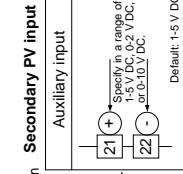
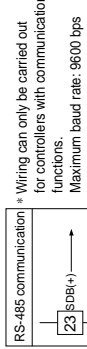
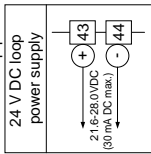

■ Receiving 4-20 mA DC Current Signals with the Controller
 * When receiving 4-20 mA DC current signals, set the PV input type to 1-5 V DC (setpoint "41").

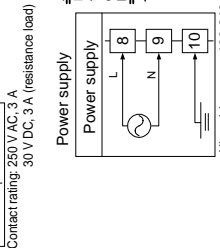
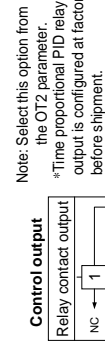
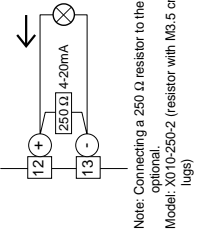

CAUTION
 Before carrying out wiring, turn off the power to the controller and check that cables to be connected are not alive with a tester or the like because there is a possibility of electric shock.

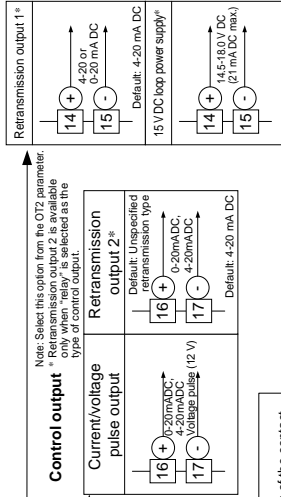

* Factory-set to "PV retransmission."

Load resistance: 600 Ω or less

* Retransmission output 1 is not available if a 15 V DC loop power supply is used.

* The functionality of a contact input can be varied by changing the setting of the contact input registration parameter.

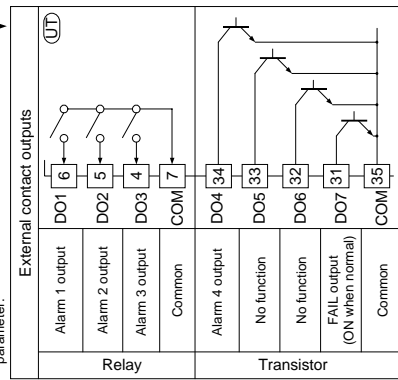

Relay contact rating: 240 V AC, 1 A
 Transistor contact rating: 24 V DC, 50 mA

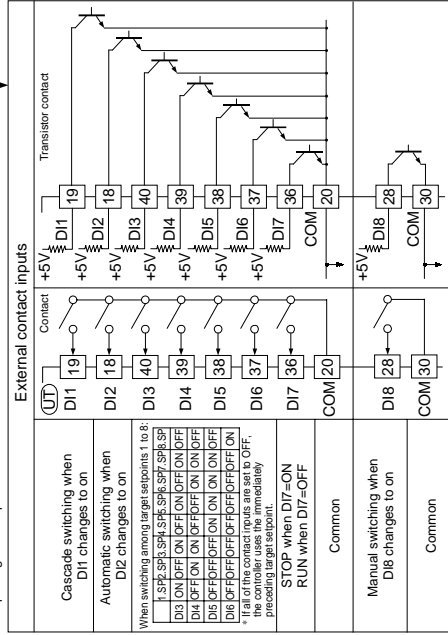

Note: External Contact Input
 If the power is turned on when the external contact input (either of Cascade, Automatic, and Manual) is ON, the controller judges that the external contact input is changed to ON.

* OT2 is a setup parameter.
 You can change the settings of the parameter OT2 to change the control output type.

Correspondence between parameter OT2 and control output types	
OT2=0 (factory-set default)	OT2=1
Time proportional control Relay output (terminals ①, ② and ③)	Time proportional control Voltage pulse output (terminals ④ and ⑤)
OT2=2	OT2=3
Current output (terminals ⑥ and ⑦)	On-off control Relay output (terminals ⑧ and ⑨)

External Dimensions and Panel Cutout Dimensions

Unit: mm

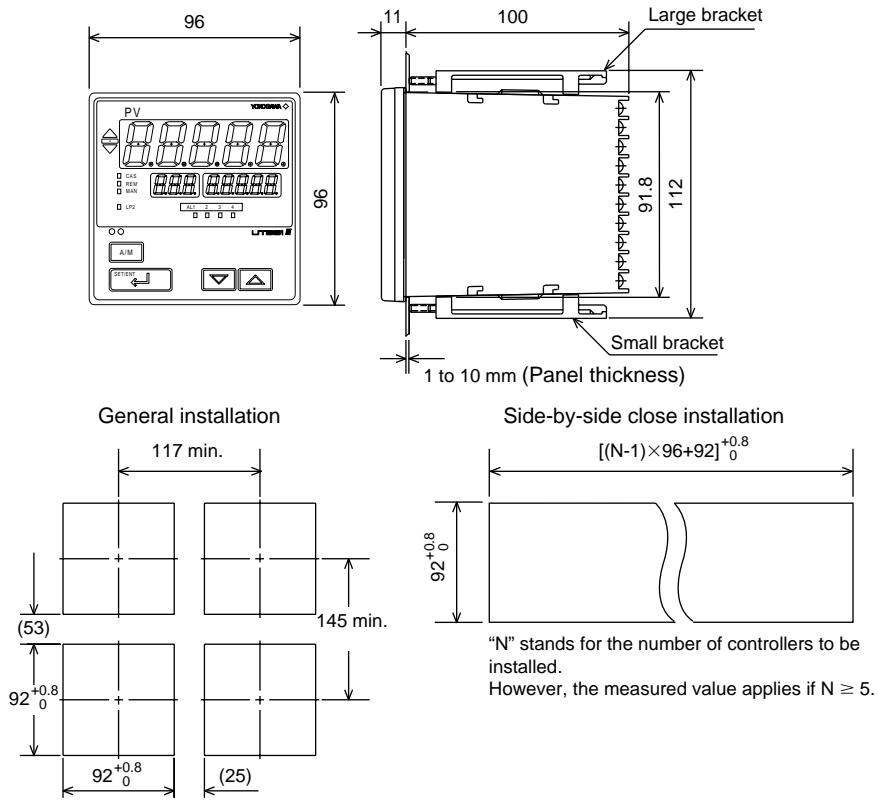

■ Model and Suffix Codes

Model	Suffix Code	Description
UT551		Digital indicating controller (provided with retransmission output and 15 V DC loop power supply as standard)
Type	-0	Standard type
	-1	Position proportional type
	-2	Heating/cooling type
	-3	Standard type (with 24 V DC loop power supply)
	-4	Position proportional type (with 24 V DC loop power supply)
Optional functions	0	None
	1	With communication, auxiliary analog (remote) input, 6 additional DIs and 4 additional DOs
	2	With communication, auxiliary analog (remote) input, and 1 additional DI
	3	With 5 additional DIs and 4 additional DOs
	4	With auxiliary analog (remote) input and 1 additional DI

Standard accessories: Brackets (mounting hardware), unit label, User's Manuals, and User's Manual (reference) (CD-ROM version).

Specify the required Suffix codes according to the UT mode to be used.

Correspondence between UT mode and suffix code

UT mode	Suffix code	00, 03,	01, 02,	10, 13,	11, 12,	21, 22,	Remarks
		20, 23,	04,	40, 43	14,	24	
Single-loop control (UT mode 1)	Cond.	App.	Cond.	App.	App.	Cond.: Remote target setting not available The remote target setting function requires the auxiliary analog input (optional function) to be specified.	
Cascade primary loop control (UT mode 2)	N/A	App.	N/A	N/A	Cond.	Cond.: UT mode 2 not available UT mode 2 can be used if one output is specified without employing heating/cooling (two outputs) functions.	
Cascade secondary loop control (UT mode 3)	N/A	App.	N/A	App.	App.		
Cascade control (UT mode 4)	N/A	App.	N/A	App.	App.	Auxiliary analog input is used for the cascade input.	
Loop control for backup (UT mode 5)	N/A	App.	N/A	App.	App.	Auxiliary analog input is used for the tracking input.	
Loop control with PV switching (UT mode 6)	N/A	App.	N/A	App.	App.	Auxiliary analog input is used for the PV input 2.	
Loop control with PV auto-selector (UT mode 7)	N/A	App.	N/A	App.	App.	Auxiliary analog input is used for the PV input 2.	
Loop control with PV-hold function (UT mode 8)	Cond.	App.	Cond.	App.	App.	Cond.: Remote target setting not available The remote target setting function requires the auxiliary analog input (optional function) to be specified.	

App.: Function available, Cond.: Function available conditionally, N/A: Function not available

■ Correspondence between the Model and Suffix Codes, and the Contact Input/Output Terminals Provided

Check the model ordered and the presence/absence of contact inputs and outputs in the following table.

✓ indicate that the contacts are available.

Model and Suffix Codes	Contact input terminals								Contact output terminals						
	DI1	DI2	DI3	DI4	DI5	DI6	DI7	DI8	DO1	DO2	DO3	DO4	DO5	DO6	DO7
UT551-□0	✓	✓							✓	✓	✓				
UT551-□1	✓	✓	✓	✓	✓	✓	✓	✓	✓	✓	✓	✓	✓	✓	✓
UT551-□2	✓	✓						✓	✓	✓	✓				
UT551-□3	✓	✓	✓	✓	✓	✓	✓		✓	✓	✓	✓	✓	✓	✓
UT551-□4	✓	✓						✓	✓	✓	✓				

■ Items to be Specified When Ordering

Model and suffix codes, necessary/unnecessary of User's Manual or QIC.